

**NOTES**

1. WHEN THIS DRAWING IS USED AS AN ORDER SUBMITTAL, IT MUST BE SIGNED, AND AN ORDER SUBMITTAL FORM MUST BE INCLUDED.
2. 30 YEAR WARRANTY COVERAGE - SEE INTERCEPTOR LIMITED WARRANTY FOR DETAILS
3. OPTIONAL ACCESSORIES (LEVEL ALARMS) ARE ALSO AVAILABLE.
4. INLET AND OUTLET PIPING DIAMETER IS 4" (MINIMUM) AND MUST BE INDICATED ON THE ORDER SUBMITTAL FORM.
5. ALL UPC LABELED GREASE INTERCEPTORS MUST SHIP FROM THE ANAHEIM FACILITY.

**DESIGN PARAMETERS**

1. TANK SIZE: 6' DIA SINGLE-WALL, 72" O.D.
2. NOMINAL TANK CAPACITY: 4,500 GALLONS.
3. NOMINAL TANK WEIGHT: 2,800 LBS.
4. INVERT DIMENSION FROM GRADE.
5. CAPACITY AT FLOW LINE: 4188 GALLONS.
6. MAX GREASE CAPACITY: 3185 GALLONS.
7. MAX SOLIDS CAPACITY: 728 GALLONS.

**APPROVAL**

THE UNDERSIGNED ACKNOWLEDGES AND AGREES TO THE USE AND DESIGN PARAMETERS AS DETAILED ON THIS DRAWING AND IN THE ACCOMPANYING ORDER SUBMITTAL FORM AND HEREBY APPROVES FABRICATION.

SIGNATURE \_\_\_\_\_

PRINTED NAME \_\_\_\_\_ DATE \_\_\_\_\_

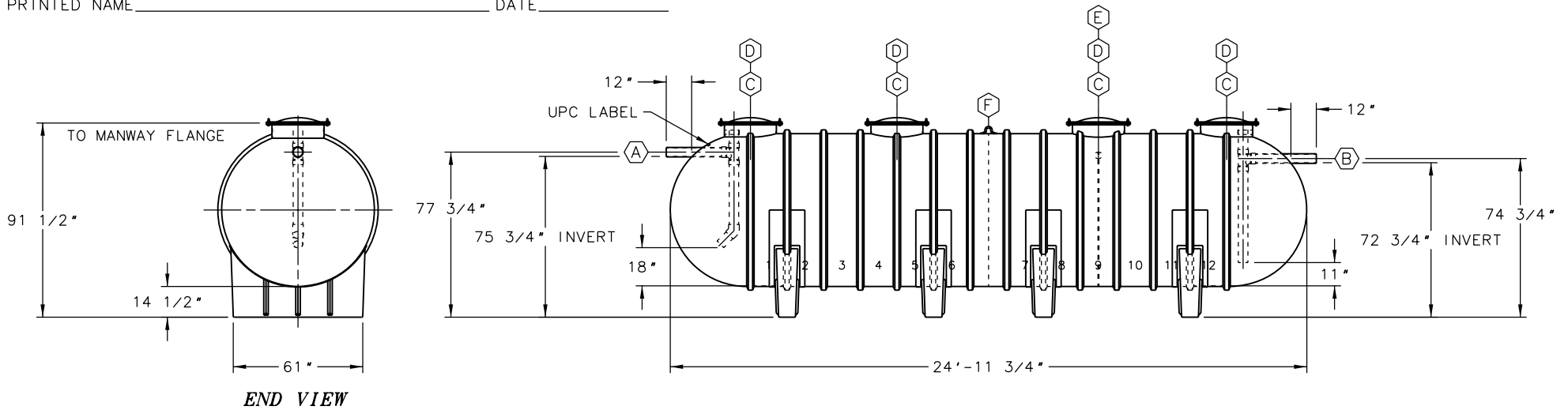
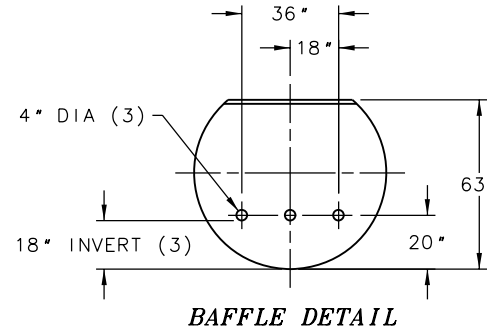
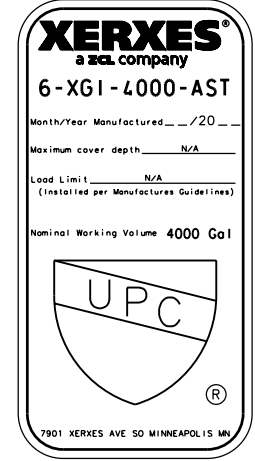

ITEM	QTY	DESCRIPTION
(A)	1	SCH 40 PVC INLET PIPE WITH INTERNAL SANITARY TEE, PIPES & 45° ELBOW
(B)	1	SCH 40 PVC OUTLET PIPE WITH INTERNAL SANITARY TEE & PIPES
(C)	4	24"DIA MANWAY WITH FRP COVER (30" OD FLANGE)
(D)	4	STUD BOLT RING FOR 24"DIA MANWAYS (30" OD FLANGE)
(E)	1	63" HIGH PLATE BAFFLE WITH 3-4"DIA HOLES (18" INVERT)
(F)	1	LIFTING LUG

**ZCL | XERXES®**

TITLE  
**MODEL G1-6-4000-UPC-AST  
 GREASE INTERCEPTOR**

DATE 1-17 DR. NO. S11-951.00

INDUSTRY TYPE: M210 PLUMBING ENGINEERED SOLUTIONS